

**The information contained in this document
is intended for healthcare professionals only.**

Apex® Pin Fixation System

Half Pins, Transfixing
Pins & Instruments



Introduction

The Apex® Pin has been a success for nearly 20 years.

The self-drilling pin technology was introduced in 1987, and Apex® Pins continue to be implanted many times a day throughout the world. This proven clinical experience reinforces the high quality design of the system.

Solid pin fixation is essential for effective external fixator frames.¹ A well designed pin can help to improve treatments, and may reduce the risk of complications.² The Apex® Pin uses advanced thread geometry to yield outstanding cutting performance and optimal pin fixation.

The Apex® Pin range offers a wide selection of pins in various lengths and diameters to meet the different needs of each application. Stainless Steel and Titanium Self-Drilling/Self-Tapping Pins offer a one-step insertion where pre-drilling is not required. Stainless Steel Blunt Pins help reduce soft tissue irritation around the tip of the pin; pre-drilling is needed. Stainless Steel Cancellous Pins are especially designed for a strong grip in cancellous bone and require pre-drilling as well. Self-Drilling Stainless Steel Transfixing Pins are available threaded or smooth and are indicated for bilateral frame constructs.

1. Eric Ledet, PhD., Director of the Orthopaedics Research Library, Albany Medical College; Biomechanical Factors in External Fixation and Hybrid External. Stryker® White Paper 2004. Literature# LSA48

2. Wikenheiser MA, Market MD, Lewallen DG, et al. Thermal response and torque resistance of five cortical half pins under simulated insertion technique. J. Orthop Res 1995; 13: 615-619

Technical Details

Self-Drilling/Self-Tapping Apex® Pin

Pin Design

The self-drilling tip of the Apex® Pin acts like a new, sharp drill bit every time; therefore, pre-drilling is not necessary. Combined with the unique cutting geometry, this one-step procedure allows the pin to maintain reduced insertion temperature, below 50°C, due to decreased friction.³

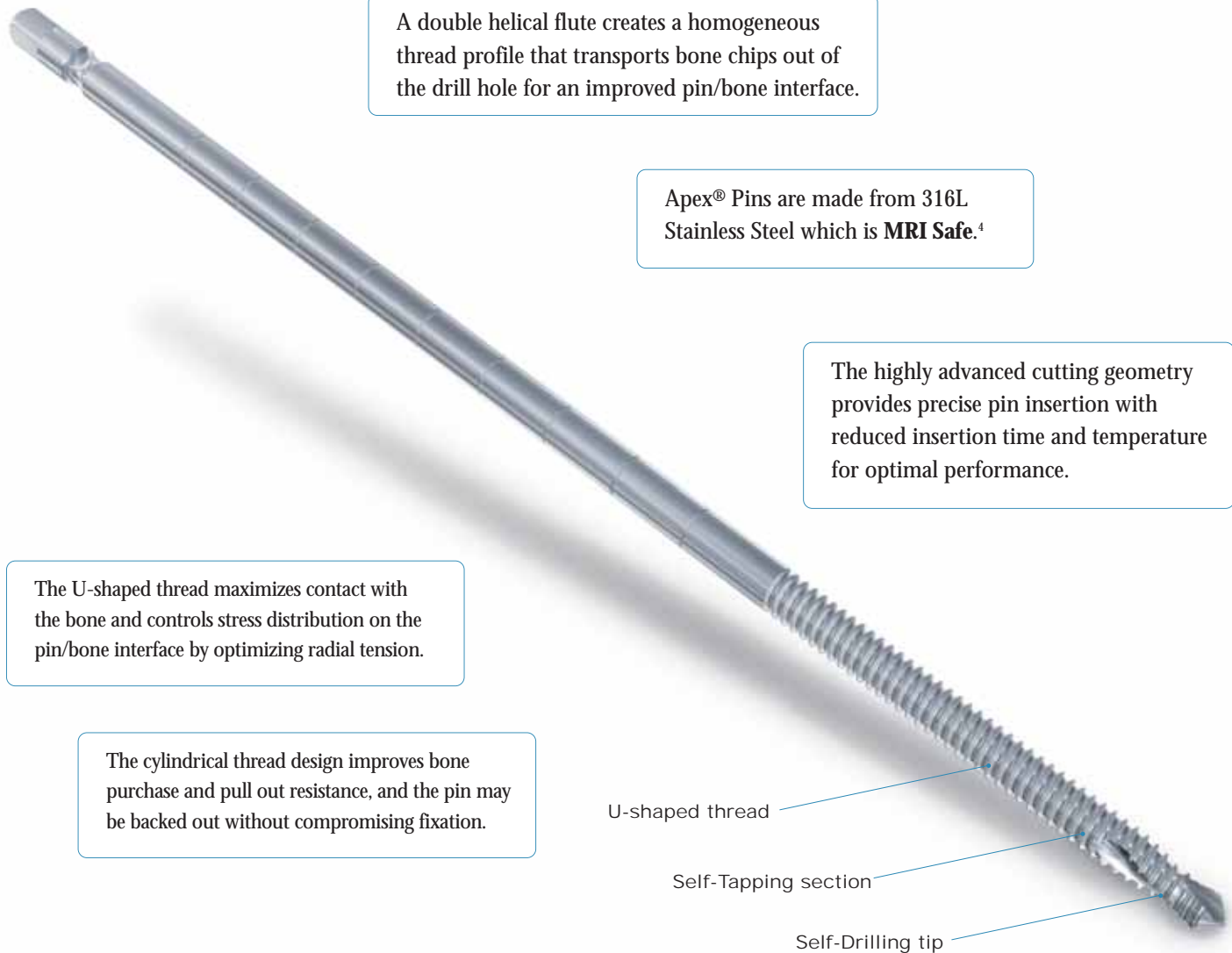

A double helical flute creates a homogeneous thread profile that transports bone chips out of the drill hole for an improved pin/bone interface.

Apex® Pins are made from 316L Stainless Steel which is **MRI Safe**.⁴

The highly advanced cutting geometry provides precise pin insertion with reduced insertion time and temperature for optimal performance.

The U-shaped thread maximizes contact with the bone and controls stress distribution on the pin/bone interface by optimizing radial tension.

The cylindrical thread design improves bone purchase and pull out resistance, and the pin may be backed out without compromising fixation.

U-shaped thread

Self-Tapping section

Self-Drilling tip

3. Andrienne Y, Wagenknecht M, Donkerwolcke M, Zurbuchen C, Burny F, External Fixation Pin: An In Vitro General Investigation. Orthopedics 1987 Vol. 10, No 11

4. John Nyenhuis, PhD; Professor of Electrical and Computer Engineering, Purdue University. Magnetic Resonance Imaging Testing of External Fixation Frames: Stryker® Hoffmann® II MRI vs. Synthes® MRI Safe. Stryker® White Paper 2005 Literature# LSA55

Instruments

Apex® Instruments

Drill Brace

The Drill Brace is designed for manual pin insertion for better control and reduced insertion temperature.

It provides integrated attachments for 3mm & 4mm and 5mm & 6mm pins. Simply by changing the Drill Handle from one end to the other you gain access to the different attachments.

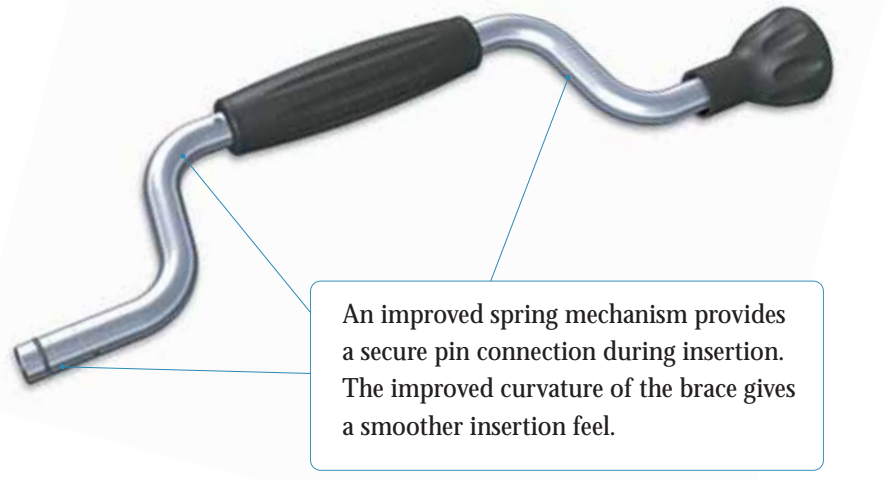

Drill Guide

The Drill Guide is designed for simplified parallel pin insertion. The color coded Drill Guide Blocks provide the correct distance for the various pin clamps of the Hoffmann® II, Hoffmann® II Compact™ and Monotube® TRIAX™ systems. The color coding matches the colors of the various systems for easier selection.

The Drill Guide Block allows perpendicular and horizontal attachment to the handle, adapting to anatomic requirements.

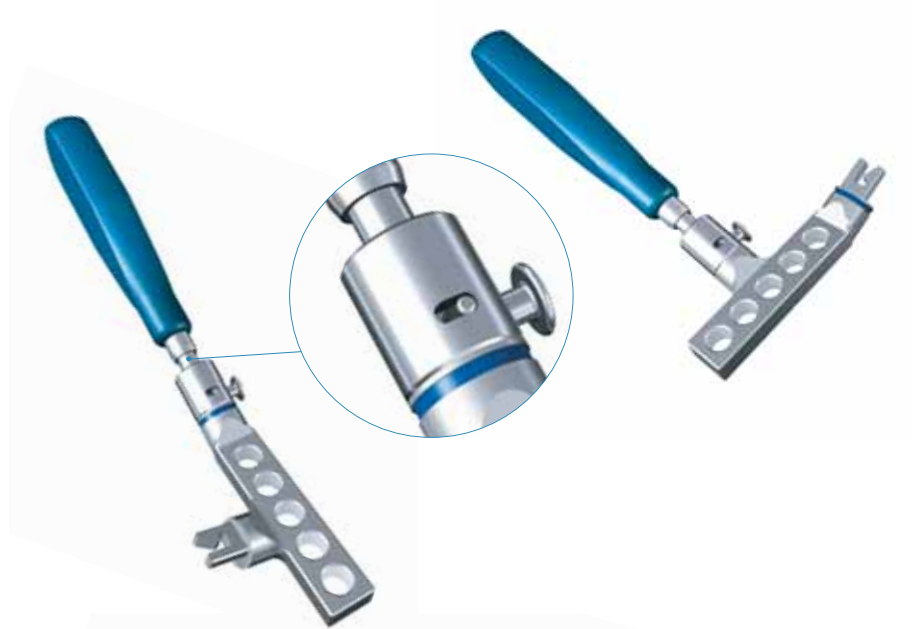

Pre-Drilling Assembly

The Pre-Drilling Assembly consists of a Trocar, a Drill Sleeve and a Soft Tissue Protector which allows for pre-drilling and pin insertion without causing additional damage to the soft tissues. Different lengths enable you to choose the correct device for the soft tissue envelope.



Instruments

Apex® Instruments

Figure 1 illustrates manual Apex® Pin Insertion using the Drill Brace, Drill Guide and Pre-Drilling Assemblies.



Figure 1

Quick Release Apex® Chuck

The Quick Release Apex® Chuck is designed for fast and easy engagement of the Apex® Pins and has a standard AO and a tri-flange connector. It is designed for insertion of Apex® Pins by power.



Combination Wrench/Pin Inserter

The Hoffmann® II T-Wrench/Pin Inserter is used to insert 5mm & 6mm pins and tighten 7mm bolts. The Hoffmann® II Compact™ Combination Wrench is used to insert 3mm & 4mm pins and tighten 5mm bolts.



Note:

For the final seating in the second cortex the T-Wrench/Pin Inserter or the Drill Brace should be used.



Implants

Apex® Pin Range

Self-Drilling/Self-Tapping Pin

Stainless Steel and Titanium Self-Drilling/ Self-Tapping Pins allow a one-step procedure through advanced self-drilling and cutting technology.



Blunt/Self-Tapping Pin

Stainless Steel Blunt Pins help to reduce soft tissue irritation around the tip of the pin. Pre-drilling is required for this pin.

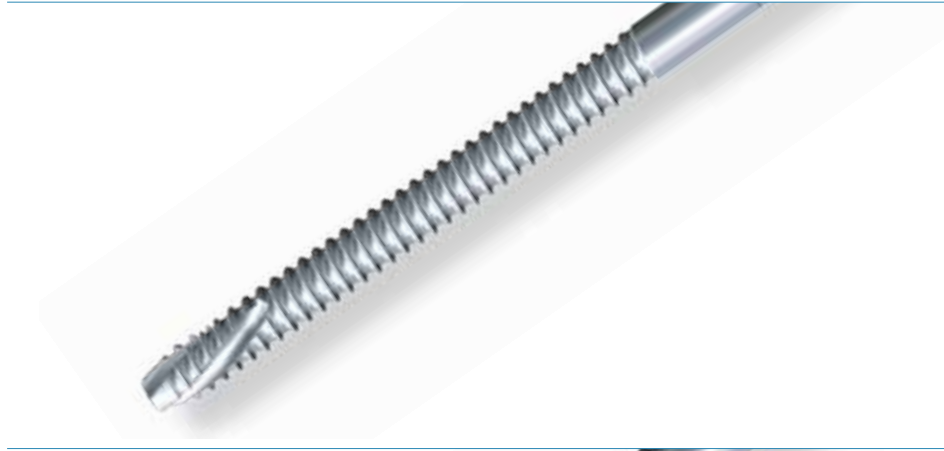

Cancellous Pin

Stainless Steel Cancellous Pins are designed for a strong grip in cancellous bone. The specially designed thread provides an increased contact area between the cancellous bone and the pin. This pin is blunt and requires pre-drilling.

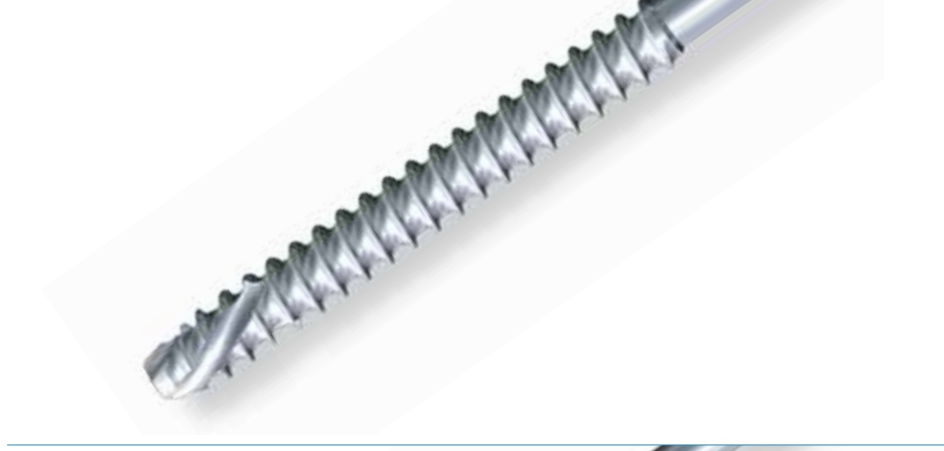

Transfixing Pin

Self-Drilling Transfixing Pins are available threaded or smooth and are indicated for bilateral frame constructs.

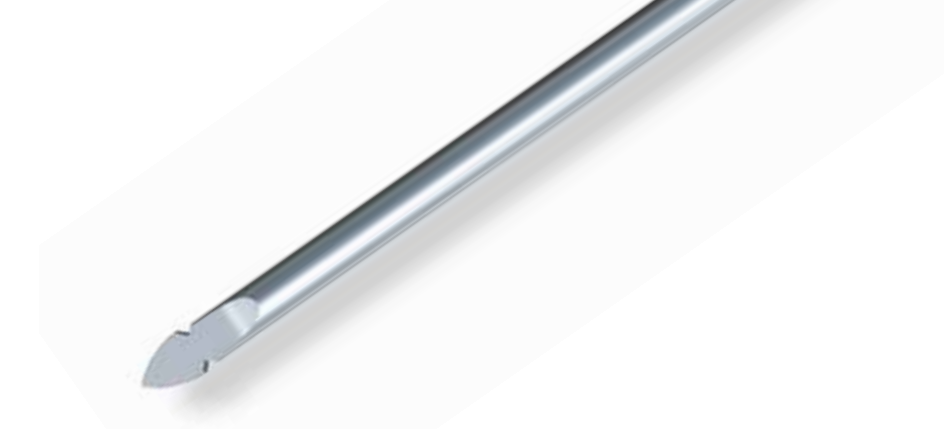

The Apex® Pin Range is safe for MRI procedures up to 3.0 Tesla. For more information refer to the Hoffmann® II MRI brochure (LH2MRIB).

Technical Details

Instructions for Use

Drill Brace

The Drill Brace provides attachments for 3mm & 4mm pins on one end and 5mm & 6mm pins on the other end. For pin insertion, place the pin into the end correlating to the chosen pin diameter.

To access the different attachments for the pins, remove the handle and assemble it on the other end.



Drill Guide Block

To assemble the Drill Guide Block, choose the correct block for your pin clamp. Set the Drill Guide Block horizontal or perpendicular and push it onto the handle. To release the block, push the button on the handle and pull it off.

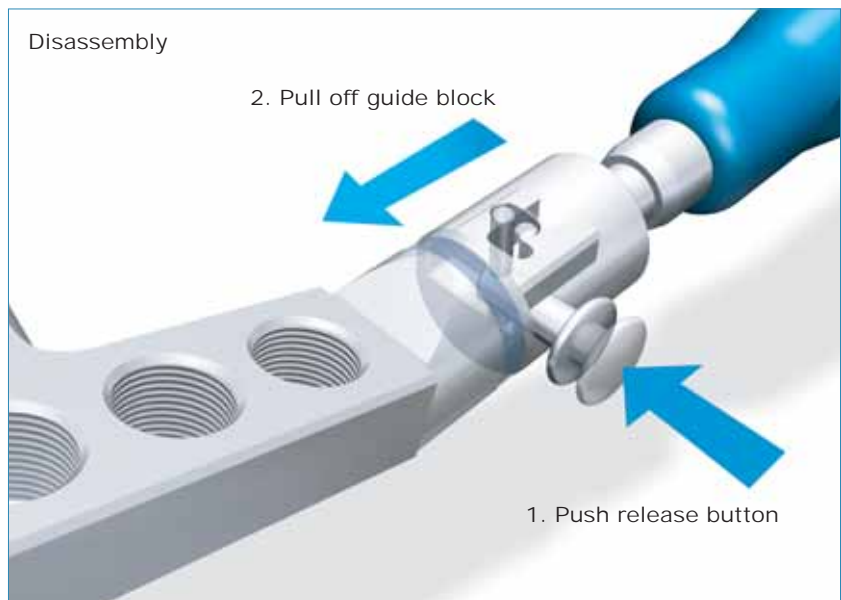

Quick Release Apex® Chuck

To assemble the pin to the chuck, pull the sleeve toward the adapter and place the pin in the adapter. To secure the pin, push the sleeve back.

To release the pin from the adapter pull the sleeve toward the adapter and remove the adapter from the pin.

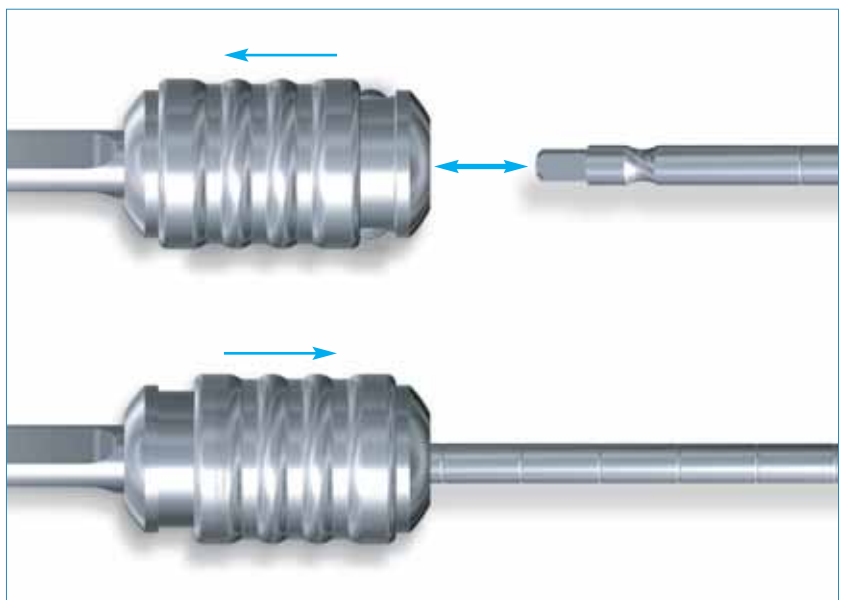

Technical Details

Pin Insertion Guidelines

The maximum pin diameter should not exceed 30% of the diameter of the bone. For example, a bone diameter of 18mm would allow a maximum pin diameter of 6mm.

Pin diameter influences axial frame rigidity. A 1mm increase in pin diameter will approximately double its stiffness and thereby increase frame rigidity.

The number of pins used in a frame construct depends on the patient condition and the indication. Increasing the number of pins will increase the frame rigidity.

When using a Self-Drilling/Self-Tapping Pin, turn the Drill Brace twice counter-clockwise to create a small notch for the pin. This helps prevent the pin from slipping on the cortex.

Afterwards, turn the Drill Brace clockwise for pin insertion.

Make a skin incision in the direction the skin will move during mobilization to avoid tension around the pin.

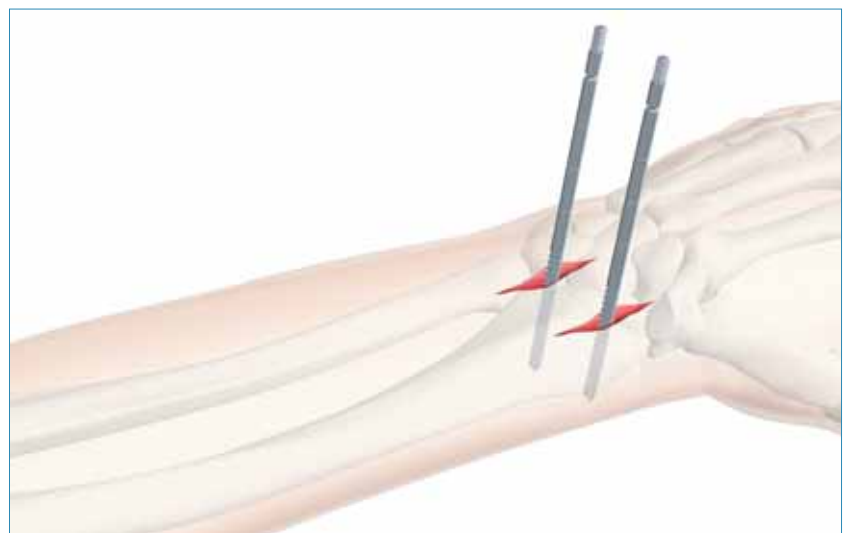
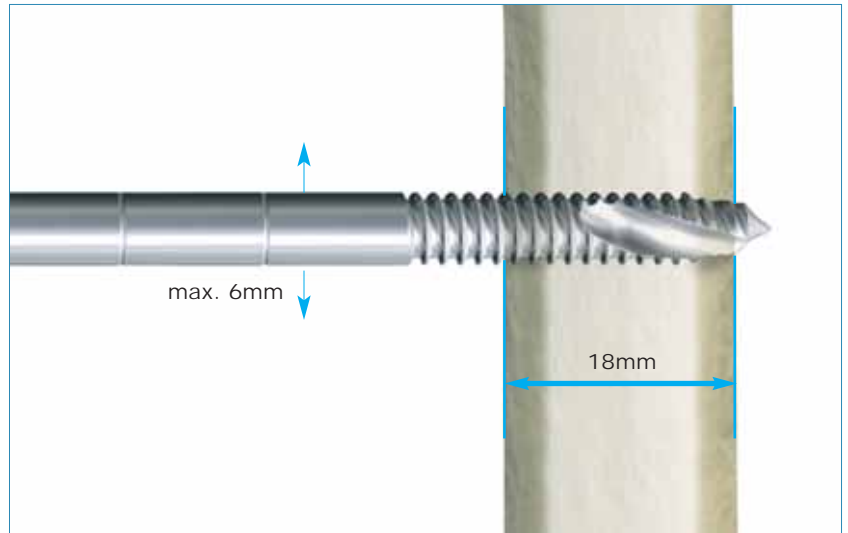

Technical Details

Pin Insertion Guidelines

When inserting the pin by power, using a low speed will limit the temperature increase, which can cause bone necrosis. Figure 2 illustrates Apex® Pin Insertion under power.



Figure 2

Insert the pins 90° to the long axis of the bone to reduce pull in and push out forces on the pins.

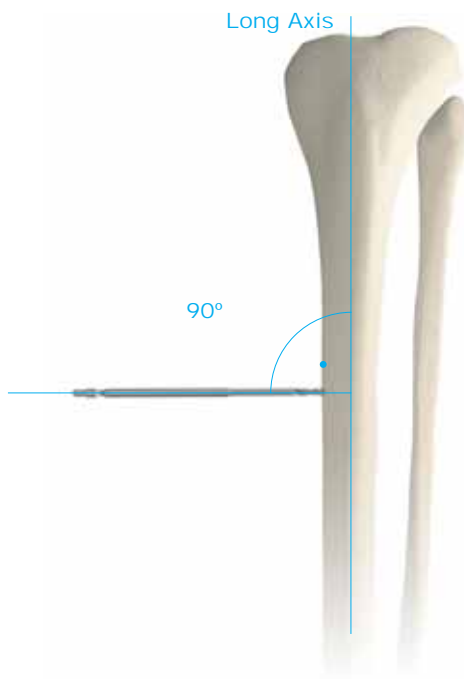

Note:
Surgeons must always rely on their own clinical judgement when deciding which treatment and product to use with their patients.

Ordering Information – Implants





Product Number	Diameter mm Thread/Shaft	Total Length mm	Thread Length mm
Self-Drilling/Self-Tapping			
5080-1-612	1.65/2.0	45	12
5080-1-620	1.65/2.0	45	20
5080-2-012	2.0	45	12
5080-2-020	2.0	45	20
5038-5-060	3.0	60	10
5038-1-080	3.0	80	10
5038-2-080	3.0	80	15
5038-5-080	3.0	80	20
5038-1-110	3.0	110	10
5038-2-110	3.0	110	25
5023-1-090	4.0	90	10
5023-2-090	4.0	90	20
5023-3-090	4.0	90	30
5023-3-120	4.0	120	30
5023-5-120	4.0	120	35
5023-5-150	4.0	150	40
5023-6-150	4.0	150	50
5023-4-180	4.0	180	40
5023-6-180	4.0	180	50
5018-3-120	5.0	120	30
5018-5-120	5.0	120	35
5018-5-150	5.0	150	40
5018-6-150	5.0	150	50
5018-3-180	5.0	180	35
5018-6-180	5.0	180	50
5018-8-180	5.0	180	60
5018-5-200	5.0	200	50
5018-6-200	5.0	200	60
5018-5-250	5.0	250	50
5018-7-250	5.0	250	70
5021-7-150	6.0	150	50
5021-6-180	6.0	180	60
5021-8-200	6.0	200	70
5021-8-250	6.0	250	80



Self-Drilling/Self-Tapping Titanium

5016-5-111	5.0	120	35
5016-5-117	5.0	150	40
5016-5-118	5.0	150	50
5016-5-122	5.0	180	50

Ordering Information – Implants

	Product Number	Diameter mm Thread/Shaft	Total Length mm	Thread Length mm
	Sterile Self-Drilling/Self-Tapping			
	5038-5-080S	3.0	80	20
	5023-5-120S	4.0	120	35
	5023-5-150S	4.0	150	40
	5023-6-150S	4.0	150	50
	5023-6-180S	4.0	180	50
	5018-5-150S	5.0	150	40
	5018-6-150S	5.0	150	50
5018-6-180S	5.0	180	60	
	Blunt/Self-Tapping			
	5065-3-312	2.0	33	12
	5065-3-615	2.0	36	15
	5065-3-918	2.0	39	18
	5065-4-520	2.0	45	20
	5065-5-020	2.0	50	20
	5065-6-020	2.0	60	20
	5065-9-015	2.0	90	15
	5036-2-060	3.0	60	10
	5036-1-080	3.0	80	10
	5036-1-580	3.0	80	15
	5036-2-080	3.0	80	20
	5036-1-110	3.0	110	10
	5036-2-110	3.0	110	25
	5027-1-090	4.0	90	10
	5027-2-090	4.0	90	20
	5027-3-090	4.0	90	30
	5027-3-120	4.0	120	30
	5027-4-120	4.0	120	35
	5027-4-150	4.0	150	40
	5027-5-150	4.0	150	50
	5027-4-180	4.0	180	40
	5027-5-180	4.0	180	50
	5020-3-120	5.0	120	30
	5020-6-120	5.0	120	35
	5020-3-150	5.0	150	40
	5020-7-150	5.0	150	50
	5020-7-180	5.0	180	50
	5020-8-180	5.0	180	60
	5020-7-200	5.0	200	50
	5020-6-200	5.0	200	60
	5020-7-250	5.0	250	50
5020-8-250	5.0	250	70	
5019-7-150	6.0	150	50	
5019-6-180	6.0	180	60	
5019-8-200	6.0	200	70	
5019-8-250	6.0	250	80	

Ordering Information – Implants

	Product Number	Diameter mm Thread/Shaft	Total Length mm	Thread Length mm
	Cancellous			
	5015-3-120	6.0/5.0	120	35
	5015-4-150	6.0/5.0	150	40
	5015-5-150	6.0/5.0	150	50
	5015-6-180	6.0/5.0	180	60
	5015-7-250	6.0/5.0	250	70

	Transfixing Pins			
	5030-3-200	5.0/4.0	200	35
	5030-4-200	5.0/4.0	200	40
	5030-5-200	5.0/4.0	200	50
	5030-3-250	5.0/4.0	250	35
	5030-4-250	5.0/4.0	250	40
	5030-5-250	5.0/4.0	250	50
	5030-6-250	5.0/4.0	250	60
	5030-4-300	5.0/4.0	300	40
	5030-5-300	5.0/4.0	300	50
	5030-7-300	5.0/4.0	300	70
	5030-5-300	6.0/5.0	300	50











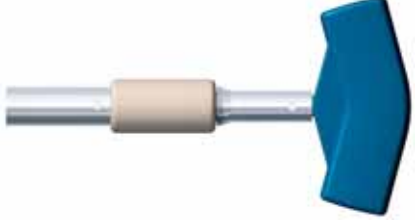

	Transfixing Smooth Pins			
	5045-5-150	3.0	150	--
	5045-5-175	3.0	175	--
	5045-5-200	3.0	200	--

Sterile Transfixing Pin			
5030-4-250S	4.0	250	40

Drill Bits for Apex® Pins

5085-1-222	Drill Bit 2.2mm x 100mm for 3mm Pins
5085-2-032	Drill Bit 3.2mm x 200mm for 4mm Pins
5085-2-040	Drill Bit 4.0mm x 200mm for 5mm Pins
5085-2-045	Drill Bit 4.5mm x 200mm for 6mm Pins

Ordering Information – Instruments

	Product Number	Description
	5057-0-300	Drill Brace Assembly
	5057-0-310	Handle for Drill Brace
	4920-9-030	7mm Wrench/5-6mm Pin Inserter
	4940-9-030	5mm Wrench/3-4mm Pin Inserter
	5057-1-003	Quick Release Apex® Chuck with AO fitting, 3mm
	5057-1-004	Quick Release Apex® Chuck with AO fitting, 4mm
	5057-1-005	Quick Release Apex® Chuck with AO fitting, 5mm
	5057-1-006	Quick Release Apex® Chuck with AO fitting, 6mm
	5057-1-110	Drill Guide Handle
	5057-1-115	Drill Guide Block, 5 hole, Hoffmann® II, blue
	5057-1-116	Drill Guide Block, 10 hole, Hoffmann® II, blue
	5057-1-117	Drill Guide Block, 4 hole, Hoffmann® II Compact™, yellow
	5057-1-118	Drill Guide Block, Hoffmann® II Compact™ Peri Articular Clamp, yellow
	5057-1-119	Drill Guide Block, 4 hole, Monotube® Triax™, blue, red
	5057-1-120	Drill Guide Block, 2 hole, Monotube® Triax™, yellow

Ordering Information – Instruments

Product Number Description

APEX® Instruments Pre-Drilling Assembly



5057-3-100	Pre-Drilling Assembly, 3.0mm, short	33mm protection length
5057-3-200	Pre-Drilling Assembly, 3.0mm, long	43mm protection length
5057-4-000	Pre-Drilling Assembly, 4.0mm, extra short	35mm protection length
5057-4-100	Pre-Drilling Assembly, 4.0mm, short	70mm protection length
5057-4-200	Pre-Drilling Assembly, 4.0mm, long	100mm protection length
5057-5-000	Pre-Drilling Assembly, 5.0mm, extra short	50mm protection length
5057-5-100	Pre-Drilling Assembly, 5.0mm, short	73mm protection length
5057-5-200	Pre-Drilling Assembly, 5.0mm, long	113mm protection length
5057-6-000	Pre-Drilling Assembly, 6.0mm, extra short	60mm protection length
5057-6-100	Pre-Drilling Assembly, 6.0mm, short	90mm protection length
5057-6-200	Pre-Drilling Assembly, 6.0mm, long	120mm protection length

Disposable End Caps

5047-1-030	Disposable End Caps 3mm (15 pieces/pack)
5047-1-040	Disposable End Caps 4mm (15 pieces/pack)
5047-1-050	Disposable End Caps 5mm (15 pieces/pack)



APEX® Storage Tray

5057-9-913	Storage Tray Lid
5057-9-912	Storage Tray Upper Insert
5057-9-911	Storage Tray Lower Insert
5057-9-910	Storage Tray Base



Joint Replacements

Trauma, Extremities & Deformities

Craniomaxillofacial

Spine

Biologics

Surgical Products

Neuro & ENT

Interventional Pain

Navigation

Endoscopy

Communications

Imaging

Patient Handling Equipment

EMS Equipment

325 Corporate Drive
Mahwah, NJ 07430
t: 201 831 5000

www.stryker.com

The information presented in this brochure is intended to demonstrate the breadth of Stryker product offerings. Always refer to the package insert, product label and/or user instructions before using any Stryker product. Products may not be available in all markets. Product availability is subject to the regulatory or medical practices that govern individual markets. Please contact your Stryker representative if you have questions about the availability of Stryker products in your area.

The marks bearing the symbol TM are trademarks of Stryker.
The marks bearing the symbol [®] are registered trademarks of Stryker.

Literature Number: LAPFB Rev. 2
MS/GS 2.5M 04/06

Copyright © 2006 Stryker
Printed in the USA